

CRY2620 Industrial Acoustic Imager User Manual V1.1



Measure Better Sound

Maintenance and Calibration

Within two years from the date of purchase, we provide free warranty service for abnormal and malfunction caused by product quality. Free warranty service does not include the non-product quality problems caused by improper use, accidental drop, etc.

In case of equipment failure caused by improper use or accidental drop, we promise to provide maintenance service at cost price.

The equipment has been calibrated when delivered to the user. However, in the long-term use process, we suggest that you send the equipment to our office every two years for equipment calibration, testing and maintenance.

Contact us

HangZhou Headquarter

Tel: 0571-88225198 0571-88225128

E-mail: cry@crysound.com

Address: No.10, Xianqiao Road, Zhongtai Street, Yuhang District, Hangzhou, Zhejiang Province.

Website: WWW.CRYSOUND.COM

Dongguan Branch

Tel: 0769-21688120

Fax: 0769-21688120

Address: 7th floor, B1 block, Songhu Zhigu Scientific Research Center, Liaobu Town, Dongguan City, Guangdong Province.

Overview

CRY2620 is the 64-MIC version hand-held industrial acoustic imager, support the ultrasonic frequencies. The instrument uses the microphone array beamforming technology to acquire the sound source distribution data, and collects the video images in real time with the high-definition camera. By integrating the sound source distribution data with the video image, the changing sound source is dynamically presented on the display screen.

CRY2620 industrial acoustic Imager helps you quickly detect potential pressurized gas leakage and vacuum leakage in noisy industrial environments. Used in power systems, it can help you quickly identify potential partial discharge fault points.

The industrial acoustics imager is made of aluminum alloy shell, which is strong and durable and can adapt to the complex and changeable working environment.

The equipment is simple and convenient to operate, and can be used quickly. It only needs to adjust two parameters, the test frequency range and test dynamic range to meet the vast majority of test requirements. Support camera mode, video mode, and the data recording on the job site is flexible. Large capacity TF data memory card can be expanded, and test results can be exported and reported quickly.

Safety instruction



To prevent possible fire or personal injury, please note:

- Please read this safety instruction carefully before using the product
- Use the product only for the specified usage
- Do not disassemble the equipment without authorization
- In case of equipment malfunction or abnormal heat, please stop using it
- Please contact the manufacturer for maintenance requirement
- Do not place the device near heat source, flame or high temperature environment
- Please do not charge the device in a high temperature environment (over 45°C)
- If internal lithium-ion battery leakage occurs, please stop using the device
- If the leakage contaminates eyes, wash with water immediately and seek medical attention
- If the leakage contaminates skins, wash with water immediately and seek medical attention
- If stored time is over 1 month, please keep the product in an environment where the ambient temperature is below 40 ° C. Otherwise, battery leakage may cause damage to the device.

Terminology

USB Power Delivery (USB PD)

A power delivery protocol based on USB3.1, which is often used to transmit more power in USB interface.

Sound Pressure Level (SPL)

A physical quantity used to express the magnitude of sound waves, the unit is decibels (dB). It is also used as dBSPL.

Audible domain

The frequency ranges of sound that can be perceived by human ears generally refers to the sound that frequency is in the frequency band of 20Hz-20KHz.

Ultrasonic

Generally, refers to the frequency of more than 20kHz sound, the human ear cannot perceive.

Sound image

It refers to the two-dimensional data table representing the intensity distribution of sound sources in the space plane after the signal collected by microphone array is calculated by the sound source location algorithm.

Palette

The color data used in the color mapping of a Sound cloud chart.

Sound cloud image

The sound pressure level data of each resolution point on the sound image is mapped to a certain color number on the palette according to a certain conversion formula to form a color image, and then it is fused with the visible image to form a sound cloud image.

Test frequency range

When a frequency range is selected within the full frequency range supported by the device, the device will only measure and display a sound cloud image that is within this frequency range. Sound outside this frequency range will not be displayed.

Frequency peak

A peak in spectrum , it denotes a strong sound energy distribution at this particular frequency.

Dynamic range





The scale of the intensity of the sound source that can be shown on the sound cloud image.

Field of view

For camera, it is an angle formed by camera and the two diagonal points of the rectangular picture which is captured by the camera.

For sound cloud image, it is an angle formed by microphone array and the two diagonal points of the rectangular sound image which is captured by the microphone array.

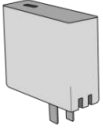
Device and accessories

Apperance	Name	Description
	<p>CRY2620</p>	<p>The industrial acoustic imager</p>
	<p>Hand straps</p>	<p>Straps accessories, help to improve the grip feeling</p>
	<p>Shoulder strap</p>	<p>shoulder strap accessories</p>
	<p>Charge connector</p>	<p>Power adapter for equipment charging</p>
	<p>Charge cable</p>	<p>Cable used to charge the device</p>

Battery and charging

Battery information

Built-in lithium-ion battery nominal capacity 6600mAh@7.2V.

Charging information:

Please charge the device through the USB Type-C port marked with the charging logo "  ". The device supports USB PD quick charging protocol. It is recommended to use a power adapter or power bank that supports 12V to 20V voltage output and the minimum output power is not less than 15W to charge the device.

Charging and endurance instructions:

- a) After inserting the charger, the charging indicator is always on, indicating that it is charging; The charging indicator is off, indicating that it is fully charged; Keep device turn off on charging. Be sure to charge the device when the device is turned off.

- b) When the battery is fully charged, the device displays 4 grids of electricity and can be used for about 4 hours; 3 grids can be used for about 2.5 to 3 hours; 2 grids can be used for about 1.5 to 2 hours; 1 grid can be used for about half an hour to 1 hour.

- c) When the battery's charge gets low, you'll see the low battery warning on the screen. Please charge in time.

Once again, please pay attention to the following contents for safe use

- Do not place the device near heat source, flame or high temperature environment
- Do not expose to the sun for a long time or use the equipment in the sun for a long time
- Do not disassemble the equipment without authorization
- Please do not charge the device in a high temperature environment (over 45°C)
- If the equipment fails or is abnormal, please stop using it
- Please contact the manufacturer for maintenance requirement

In order to extend the battery life, we suggest

- Please do not charge the device for more than 24 hours
- If it is not used for a long time, please charge the battery regularly
- It is recommended to store at -20°C to +40°C



Note: When the battery capacity is low, please contact the manufacturer to replace the battery. Do not disassemble the device without permission.

Function

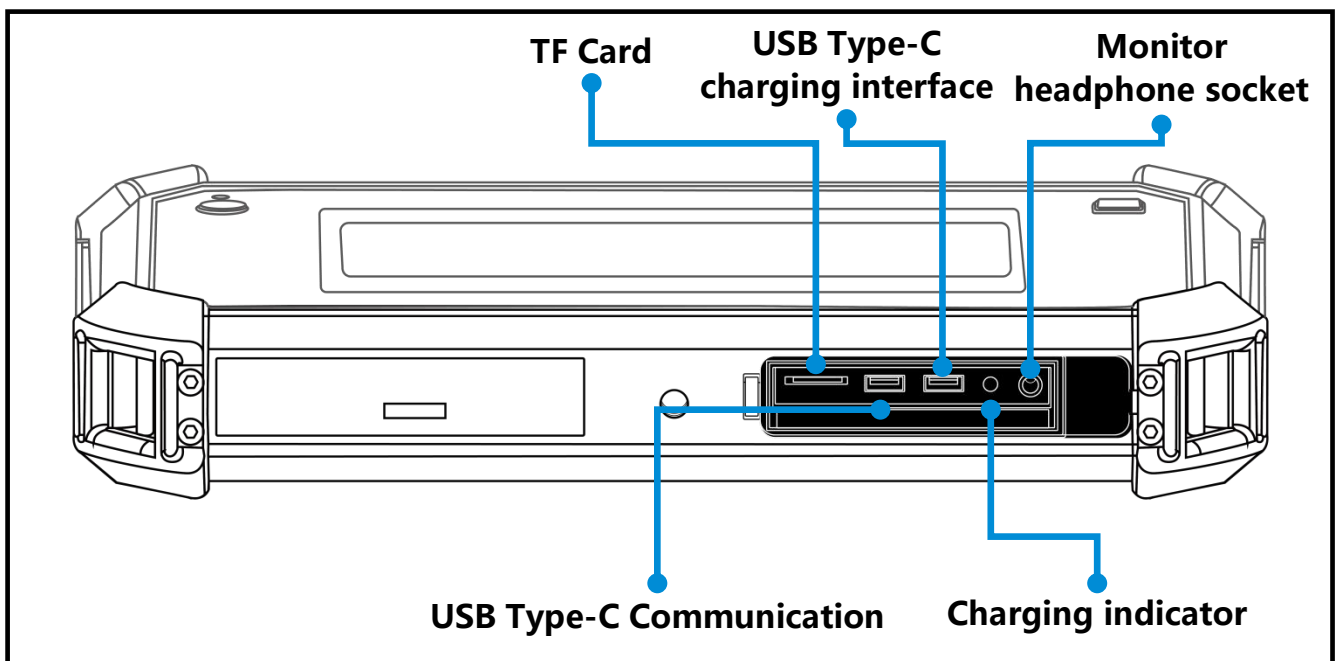
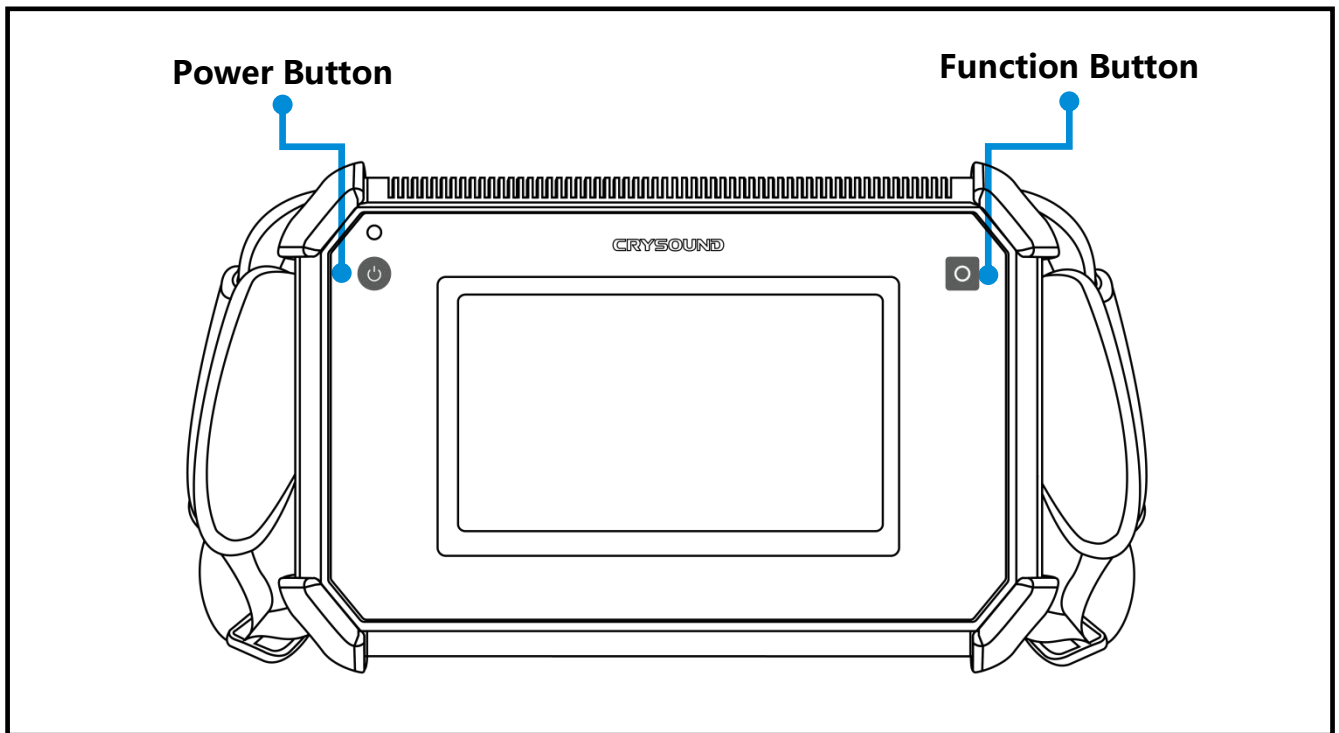

Expand TF card

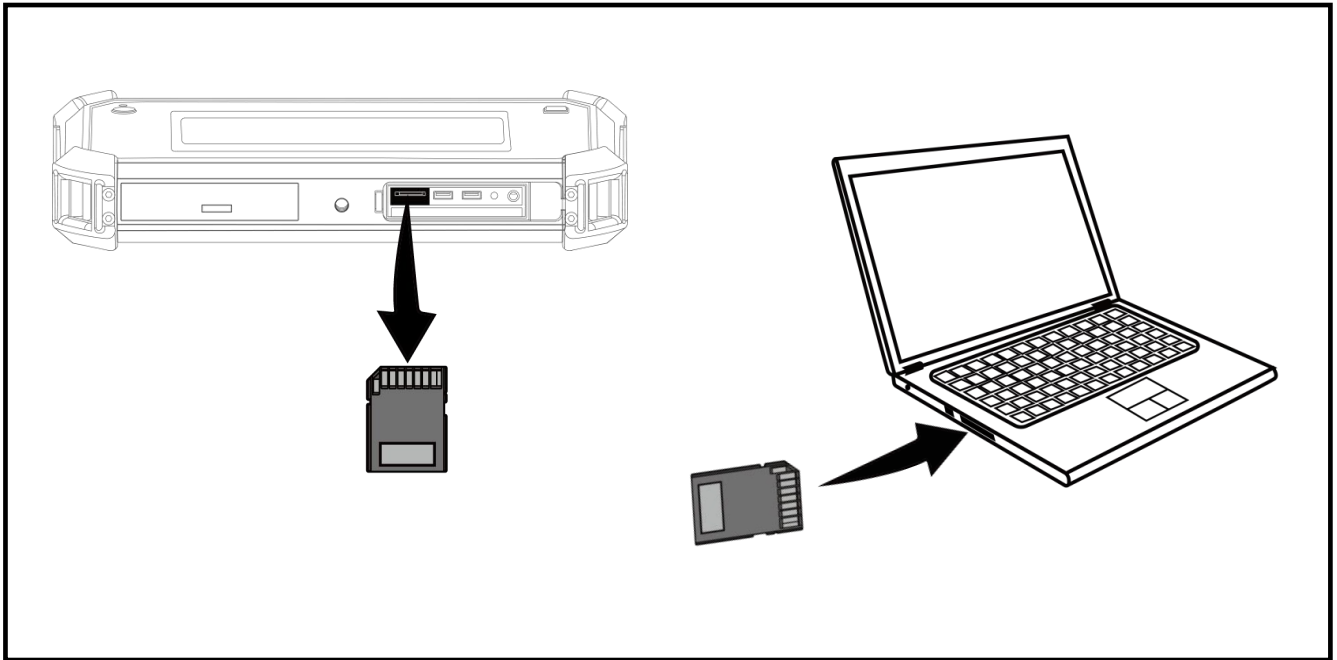

Notes for the use of TF Card

- Do not remove or insert the TF card when video recording.
- After taking photos and recording videos, please wait until the data is saved successfully before inserting and removing the TF card.
- Do not remove or insert the TF card when browsing and marking data under the playback menu.
- When reading TF card data on the PC, do not change the names of files and folders in the TF card, otherwise, test data may not be correctly identified and displayed in the playback menu.

Tripod

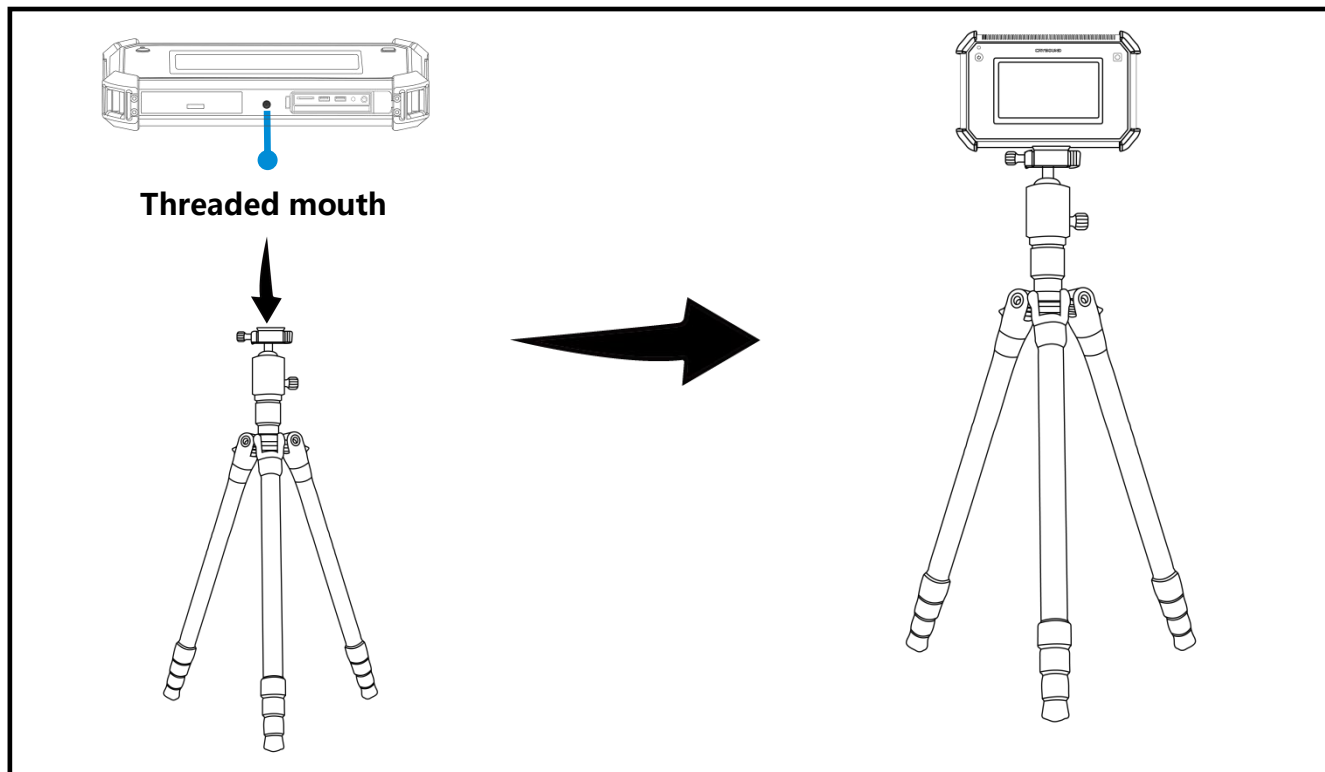

Hand straps and shoulder strap

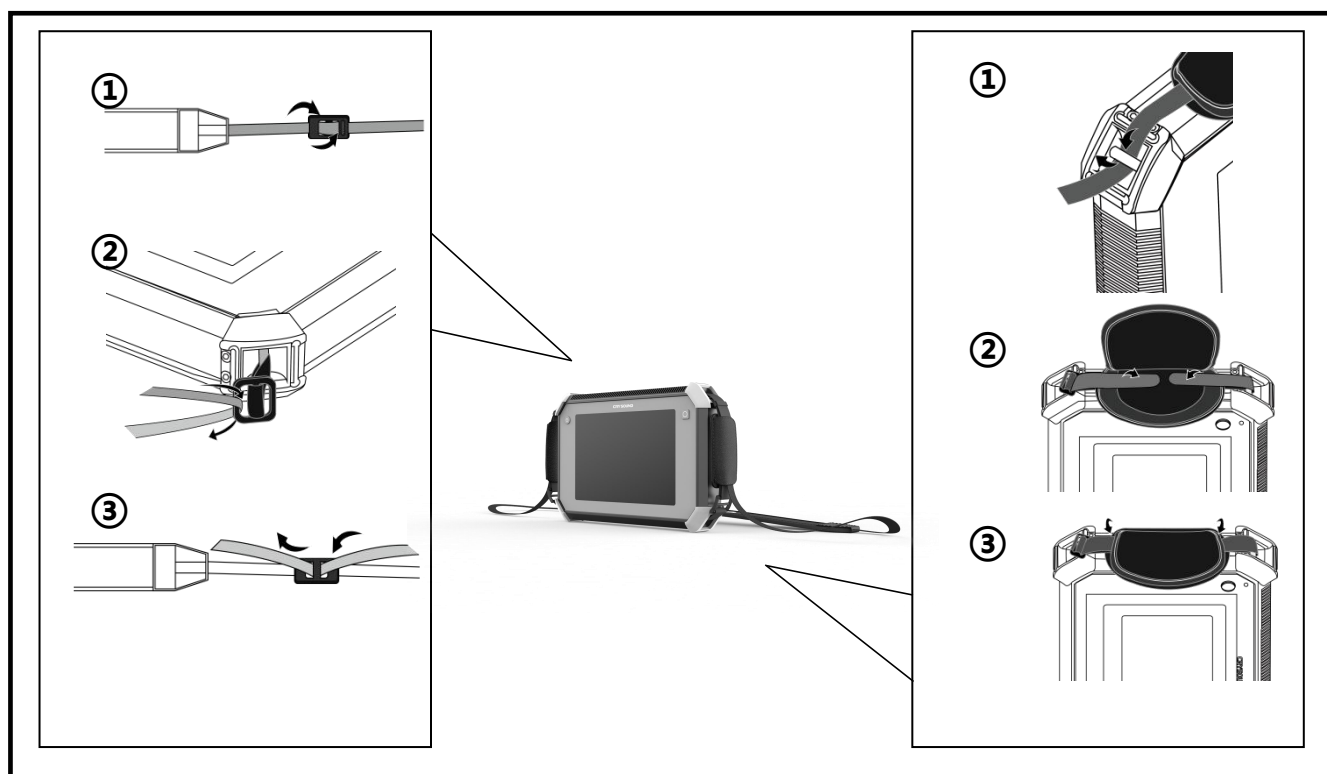

Software interface

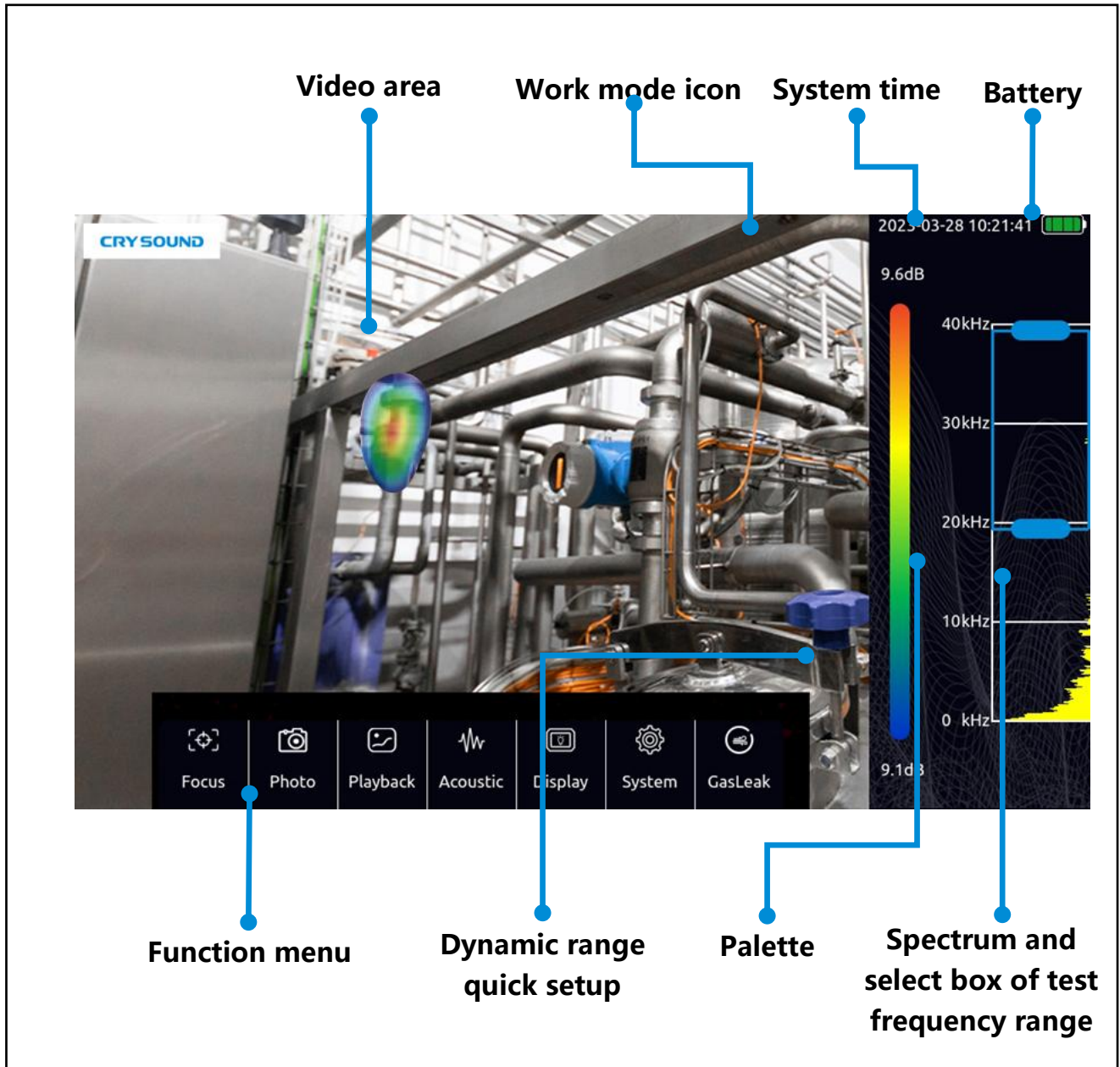

Function menu

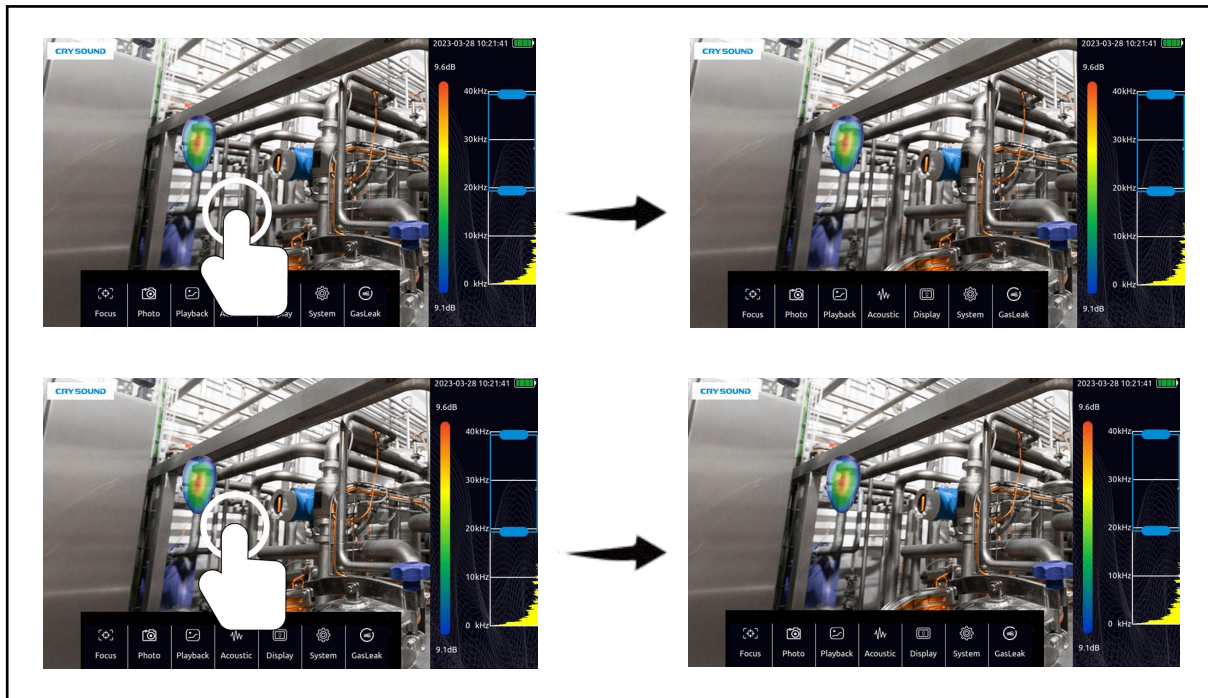

- Click in the video area of the screen to call out the menu bar
- Click again or do nothing for seconds, the menu will hide automatically

The Function menu includes



Steady-state

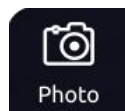

**Work mode
switch button**

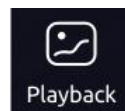

Playback



Acoustic

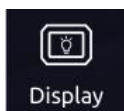

Display



System

Palette and dynamic range

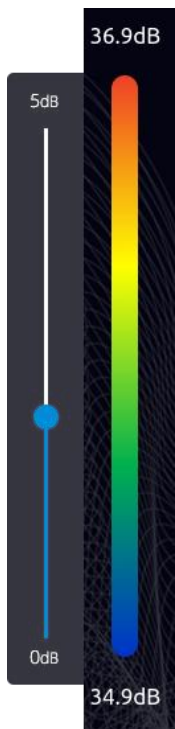

- Click the palette on the main interface to call out the dynamic range dialog
- Click the area outside the dynamic range dialog to hide it
- Dynamic range parameter can be adjusted into this dialog

Test frequency range

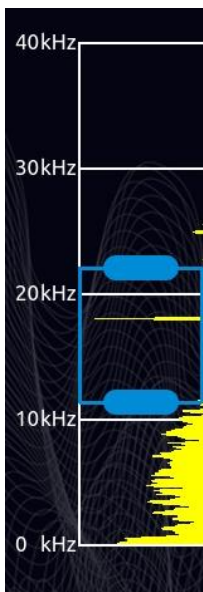

- Press on select box to move it
- Press on a single side of select box to adjust up limit or down limit

Video and photo

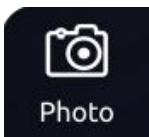
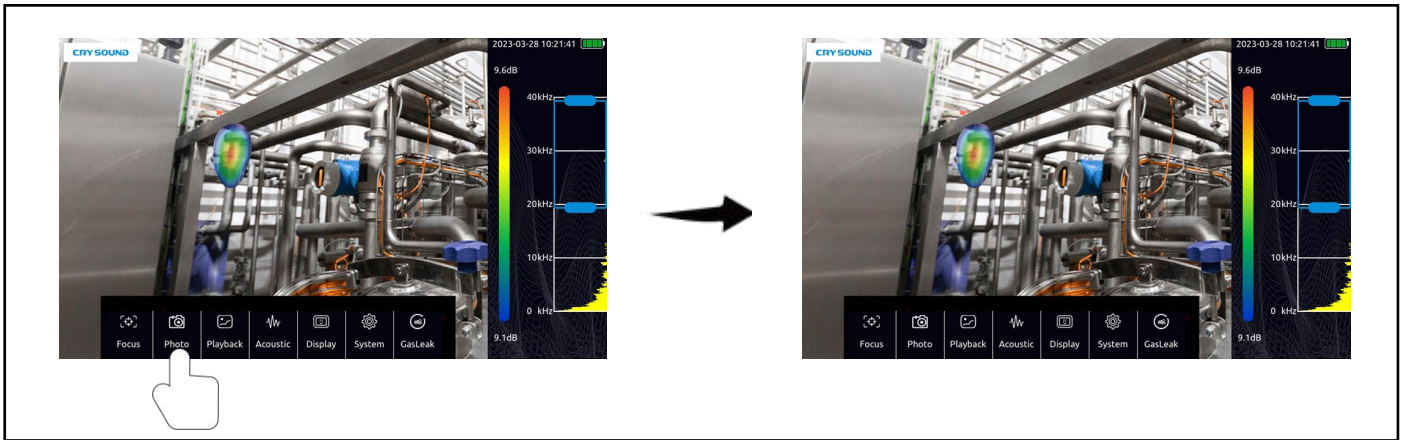

Click the button on the left of the menu bar to switch between camera mode and video mode.



The icon in the upper right corner of the video area will remind you of the work mode which the device is currently in.





- a. In camera mode, press the function button to take a picture.
- b. In video mode, press the function button to start recording, press again to stop or it will automatically stop when video exceeds 5 minutes.

During video recording, you can know the duration of current recording through the icon in the upper right corner of the video area.

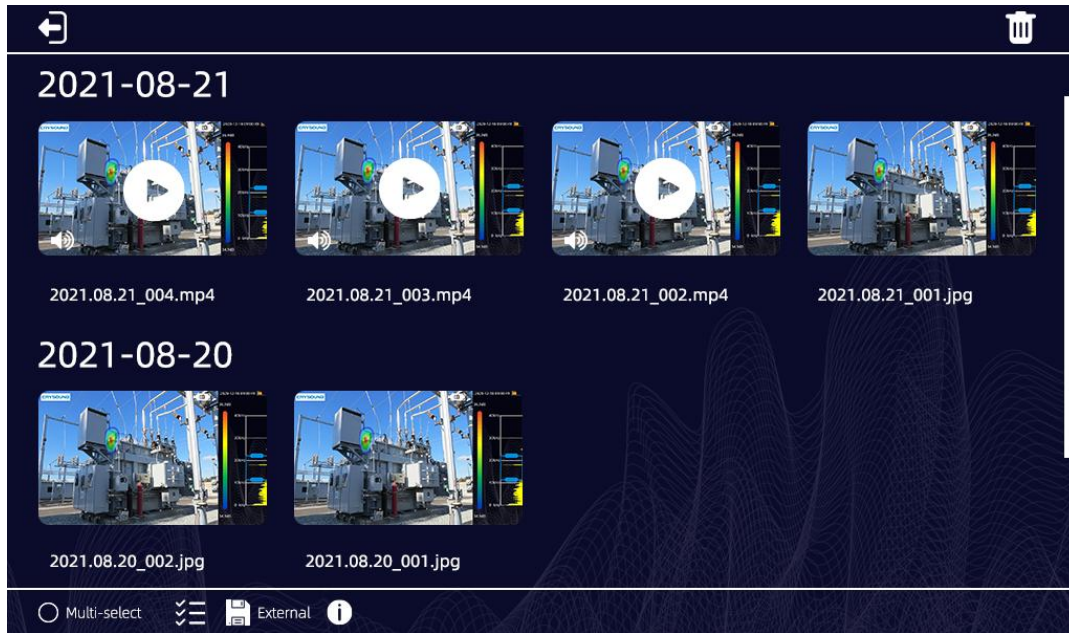
Playback

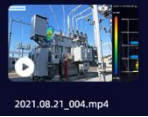
Pictures and recorded video data can be viewed in the playback window.



- a.  Click a picture or video to check full size image or play a video.
- b.  Click Multiple Selection to select multiple videos or photos for deletion.
- c.  Click the select all button to select all.
- d. After selecting a video or photo, click the upper right corner “  ” to delete the data.
- e. Press button “  ” to check usage information of current storage space.

Picture Playback

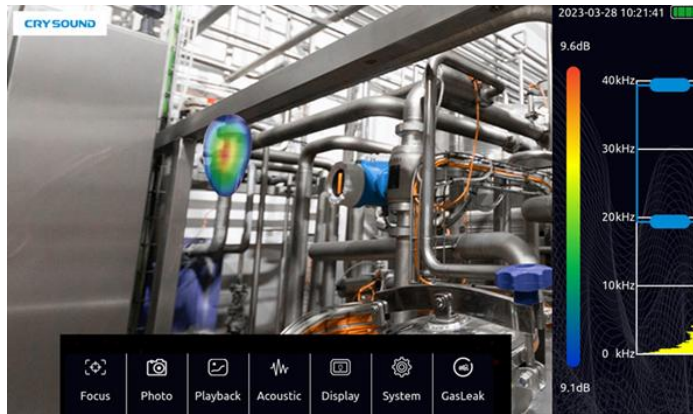

Double click the picture to enlarge and play back the picture. After enlarging the picture, you can drag the picture with your finger, and double-click the picture again to restore the original size.

Press the “ < ” and “ > ” or touch and sliding left and right to view the next or before.

Video Playback



Click the video thumbnail to zoom in and play the video.

Press on “ ▶ ” to playback a video.

Press the video to stop.

Press the “ < ” and “ > ” or touch and sliding left and right to view the next or before.

Drag the progress bar below the video to adjust the playback progress.



Picture, Audio, Text tags

In "Playback," click a video or an image and six white flag ICONS appear at the bottom of the screen. You can click the icon to mark a video or picture. The video or picture can be tagged with image, audio, and text. A total of six tag contents can be added for the three tag types.

Picture tag can take a picture as the tag content, the picture content can be nameplate, character tag, etc. Click the icon to select image markers, press the function button on the right to take a photo with the camera, click the save icon in the upper right corner to save the marked content, click the button on the right to cancel the picture taken, click the lower right corner to select the photo resolution, the marked picture supports 1920*1080, 1280*720 and 640*480 resolutions.

Audio tag can record a piece of audio as the tag content, the audio can be a human voice or other live voice. Click the icon to select the audio mark, and press the function button on the right to record an audio with the microphone in the microphone array. The audio is single channel. To improve sound recording, microphone arrays can be placed close to the source or speaker. After recording, press the function button on the right to stop recording. Click the save button to save the recording.

Text tag can input a paragraph of text as the markup content, it also supports keyboard input and two-dimensional code scanning. Click the mark icon to select the text mark and then click the keyboard icon. Click on the pop-up input box and the input keyboard will pop up. You can use the keyboard to input words, symbols, English and so on. After typing, click Save to save the text markup.

Click the icon to select the text mark and then click the two-dimensional code icon. The device will start the camera to scan the two-dimensional code automatically. Identify to the two-dimensional code will display its contained text information, press the save button to save the text information, press "re-identify" to re-identify the code again.

Acoustic

Dynamic range

- Sliding the slide to adjust dynamic range.
- Or click the palette bar on the right of the software interface to call out the dynamic dialog and quickly adjust it.

Cursor sound pressure level

- The cursor function can be turned on or off.
- When the cursor sound pressure level function is enabled, the cursor will be displayed on the video screen, and the cursor number will be displayed below the cursor. And the image energy of the position indicated by the cursor will be displayed below the photo and frequency recording status indicator in the upper right. If three cursors are set, the sound pressure level shown by the cursor 1, 2 and 3 will be displayed from top to bottom. The number of cursors can be set in System Settings > Tools > Number of cursors. A maximum of three cursors can be set.

Record sound while recording video

- Press button to enable record sound while recording video.
- When it is enabled, if you record video, the sound will be recorded as well.

Ultrasonic monitoring

The equipment can modulate the signal in the ultrasonic frequency band to the audible frequency band, and can monitor the signal with headphones.

Ultrasonic modulation is realized by superheterodyne. The reference frequency of modulation can be set. It is recommended to use a frequency band of about 38.6khz for near modulation and monitoring.

Focusing

The focusing function is mainly used to eliminate environmental interference noise, reflection noise, multi-source interference, etc. when the test environment is noisy and the cloud image is more than single one, scattered and chaotic, the focusing function can be turned on to focus the presentation of the audio-visual cloud image within a circle and eliminate other interference sources.

Double click the circle in the center of the main interface to switch the size of the test range. Double click again to restore the initial size.

Display

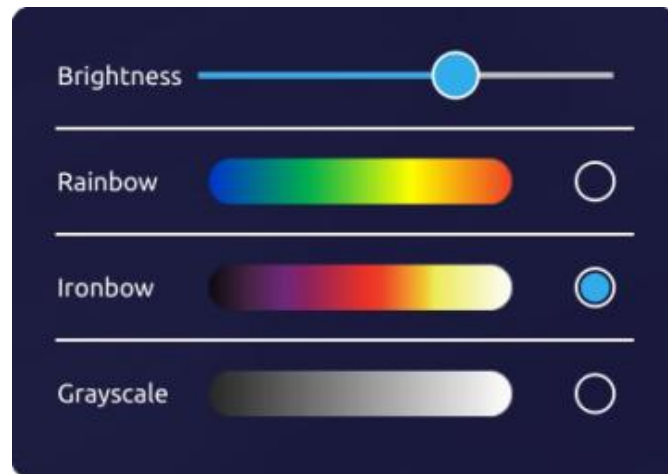

Brightness: the brightness is adjustable. When used outdoors, it is recommended to increase brightness for better visual clarity. When used indoors, it is recommended to reduce the brightness for a longer battery life.

Rainbow: set palette to use rainbow

Ironbow: set palette to use ironbow

Grayscale: set palette to use grayscale

System

Language

Chinese, English, Korean, French is supported, after selecting the language, the software will switch the language.

Time

Adjust system time.

When system time is changed, press“ update time” to take effect.

Lock

The device can implement a low power strategy . You can turn on the auto sleep function of the device.

After selecting the sleep time, the device will automatically enter the sleep mode if it does not perform any operation during the time. When the device sleeps, the power indicator will flash. By pressing the power button, the device can quickly wake up and be ready for testing.

Only when the auto sleep function is set can the device set auto shutdown.

After selecting the shutdown time, the device will automatically shutdown if it does not be awakened during the time.

Tool

Log export function: click and confirm to export the equipment operation log to the TF card. The equipment operation log is generally used by the

manufacturer to diagnose the equipment status, and users generally do not need to use it.

The number of cursors is used to adjust the number of dynamic cursor displays, which can support up to 3 dynamic cursor displays.

Sensitivity is used to set the minimum sensitivity of cloud image imaging, which can limit the imaging when the cloud image energy is higher than the sensitivity value. This function can be enabled when the button is turned on, and the sensitivity threshold can be set by sliding the slider.

About

Display device model , serial number, software version and manufacturer information.

Press “ check for update” to install a new version of software. Press “check for update” ,it will check for available packages from external storage(TF card). You can upgrade the software version by selecting the package you want to install.

Estimation of Gas Leakage

Turn on the function of gas leakage level calculation in the equipment. After opening, the software will turn on the focusing function by default to avoid interference. At the same time, the test frequency band will be fixed in the 25kHz-40kHz to ensure the accuracy of leakage calculation.

There are options of air pressure and distance on the left side of the software. The user needs to input the air pressure (unit: kPa) and distance (unit: cm) of the leaked gas according to the actual situation of the site. The software will calculate the leakage level and the approximate range of gas leakage according to the gas pressure, distance and calculated leakage energy (for reference). The gas leakage levels are divided into 7 classes and the corresponding leakage ranges are shown below:

Leakage Level	Leakage Range (Unit: ml / min, for reference)
0	< 10ml/min
1	> 10ml/min, < 200ml/min
2	> 200ml/min, < 500ml/min
3	> 500ml/min, < 1000ml/min
4	> 1000ml/min, < 1500ml/min
5	> 1500ml/min, < 2000ml/min
6	> 2000ml/min

Equipment use skills

Capture sound source

- a) Observe whether there are prominent spectral signals or spectral spikes in the spectrum diagram. If there are, move the selected box including the frequency range where the prominent spectral signal or frequency spike is, and then observe if any sound source appears.
- b) Try to adjust the dynamic range to a larger value, may simultaneously capture more than one sound source in the screen. When the SPL of multiple sources in the picture differ significantly, the relatively small dynamic range parameter may cause the larger sources to drown out the smaller one.

Exclude fake sound source cause of reflection

When you are unable to determine if the sound source is an actual sound source or a reflection one. Try to capture the sound source in different test position. If the sound source is steady, then it is supposed to be an actual sound source. A reflection one will drift or disappear when be captured in different test positions.

Exclude interfering noise

- a) It is easy to be disturbed by environmental noise in low frequency band. According to the actual situation of sound source, it is recommended to use middle or high frequency to capture the position of sound source.
- b) A relatively narrow band range is suggested to be chosen to locate the sound source, which can eliminate interference noise in other bands.

Equipment maintenance

- a) Keep acoustic sensor holes clean, prevent dust accumulation; when the hole has dust, please gently blow air to clean, do not use a wet cloth to clean.
- b) When not in use for a long time, put it into the attached package after charging, and store in a room temperature.
- c) Regular inspect and charge battery can effectively increase service life of the battery.

Technical specification

Microphone array

Microphone array: 64 channels MEMS microphone

Effective test bandwidth: 2kHz-40kHz

Sound image FOV: 62°

Sound image frame rate: at least 25 FPS

Test sound pressure level range: 28-120dBA

Leak detection rate: 10m 5bar 2.3ml/s

0.5m 5bar 2ml/s

Detect distances: 0.5-70m

Camera

Camera FOV: 62°

Camera focal length: 3.04mm fixed focal length

Camera pixel: 8million pixel

Display

Resolution: 1024*600

Size: 7 inch

Touch screen: capacitive touch screen

Brightness: adjustable

Storage

Internal storage: about 8G

External storage: expand TF memory card, at least 64G

Data storage format: .jpg (picture) and .MP4 (video)

Battery

Battery capacity: 6600mAH@7.2V

Battery life: about 4 h under full load state

Charge: USB Type-C port, USB PD protocol supported

Power consumption: 15W for battery charge; 29W for maximum power consumption

Interface

USB 3.0 Type-C USB host port

3.5mm headphone socket

Operating environment

Operating environment: -10°C- +50°C, 10%-95% no condensation

Storage temperature: -20°C – +60°C

Charging temperature: 10°C – +45°C

Mechanical

Size: 272mmx174mmx42mm

Weight: 1.7kg

Attention: Operating time of equipment in low temperature environment may be reduced.